



QDH (QUICK DISCONNECT HUB) INSTALLATION AND USER MANUAL (EN)

1) PRODUCT DESCRIPTION

- The QDH (quick disconnect hub) is a special type of hub compatible with helms that have the 3/4" standard taper shaft (compliant with EN 28848 and ABYC P22 standards).
- The QDH allows the installation and the removal of the steering wheel quickly, no tool is required, granting at the same time the expected quality and mechanical strength levels.
- The QDH is interchangeable with the ULTRAFLEX HUB X63.
- The QDH is available both as a separate part (not assembled on the steering wheel) and as an integrated part of the steering wheel: please refer to our catalogue or visit our website www.ultraflexgroup.com for the up-to-date list of the steering wheels already fitted out with the QDH.

2) BOX CONTENTS

In case of purchase of the QDH as a separate part, the box includes:

- A. **Fixed insert** (1x) (in-built part with the helm shaft, once the steering wheel is connected to the helm).
- B. **Support with release** (1x) (in-built part with the steering wheel, once the QDH is connected to the steering wheel).

NOTE: the insert (A) is supplied already assembled to the support (B).

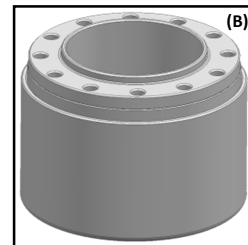
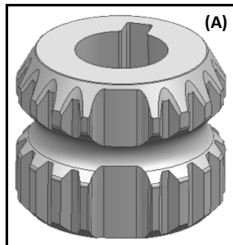

3) STEERING WHEELS COMPATIBILITY

- The QDH is designed to be used with Uflex and Ultraflex steering wheels which usually come assembled with the ULTRAFLEX HUB X63: please refer to our catalogue or visit our website www.ultraflexgroup.com for the up-to-date list of the steering wheels.
- In case of purchase of the QDH as a separate part, the installer has first to assemble the steering wheel frame to the hub (pt. 4) and, just later, he can assemble the steering wheel on the helm shaft (pt. 5). The screws to fix the steering wheel frame are supplied with the steering wheel.
- In case of purchase of a steering wheel already equipped with the QDH (already assembled on the steering wheel), the installer has only to install the steering wheel on the helm shaft (pt. 5).

⚠ ATTENTION!

UFLEX declines any responsibility for the use of the QDH with different steering wheels than those ones listed in our catalogue or in our website www.ultraflexgroup.com.

4) QDH ASSEMBLY ON THE STEERING WHEEL

- The QDH has 12 holes placed on a $\varnothing 70$ mm [2.75"] circumference: 6 out of 12 holes are used to fix the QDH to the steering wheel frame (same assembly process used for the ULTRAFLEX HUB X63).
- Use the 6 hex socket pan head screws or the 6 hex socket countersunk head screws supplied with the steering wheel: tighten the screws by the proper tool and at the torque value indicated on the screws bag.

⚠ ATTENTION !

The insert (A) and the support (B) have one wider groove and a matching tooth, respectively: these features define uniquely the orientation of the steering wheel once mounted on the helm.

In case of non equidistant spokes steering wheel, before assembling the steering wheel frame on the support (B), please check the proper set of holes in order to get the steering wheel and the rudder straight (pt. 7).

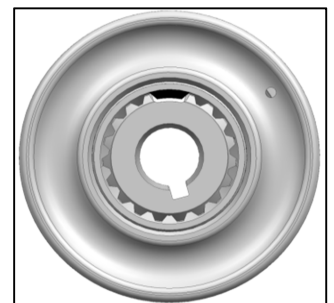
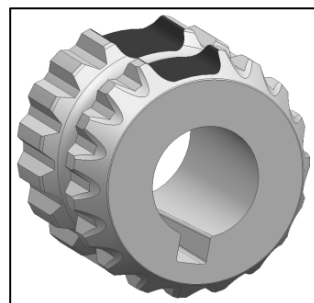
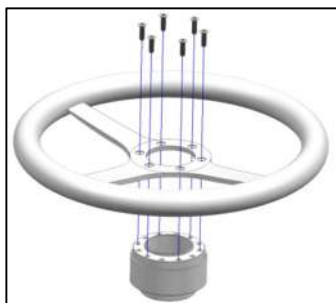

5) STEERING WHEEL INSTALLATION ON THE HELM

NOTE: first installation of a steering wheel fitted with the QDH is the same of an installation of a steering wheel fitted with a traditional hub.

5.1 Place the key, supplied with the helm, into the key seat on the shaft.

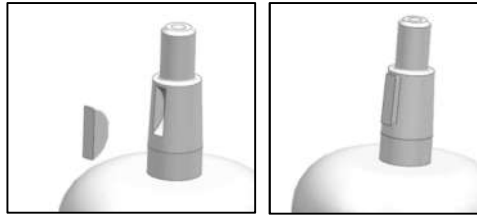

5.2 Make sure that the insert (A) is locked inside the support (B) (pt. 2).

5.3 Put the QDH on the shaft, taking care of aligning the key with the key seat in the insert (A).

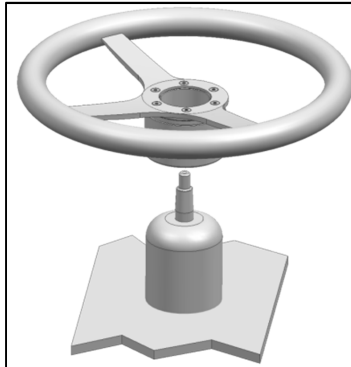

⚠ ATTENTION !

Pay close ATTENTION that the key does not go out from the shaft key seat when mounting the steering wheel.

5.4 Insert the washer on top of the shaft and tighten the nut holding the steering wheel during the operation: tighten the nut by the proper wrench and at the torque value indicated in the helm user manual (nut and washer supplied with the helm).

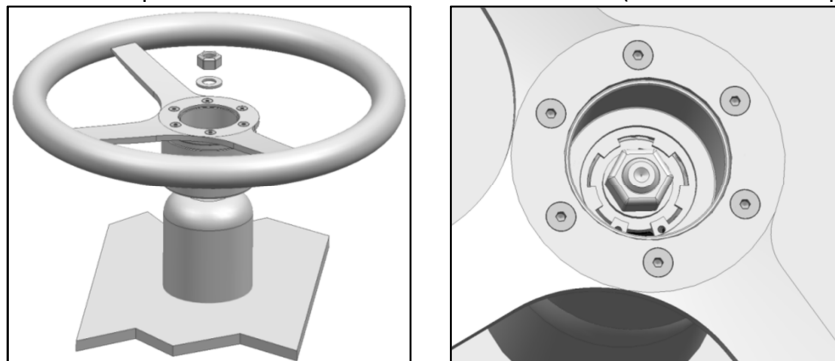

6) OPERATING USE OF THE QDH

✓ How to remove the steering wheel.

1. Pull up the release part (E) towards the steering wheel frame and remove the steering wheel (still keeping the release part (E) pulled towards the steering wheel).
2. Part (E), once released, goes back to the working position.
3. The fixed insert (A) remains in-built with the helm shaft and it must not be removed.
4. The support with release (B) stays in-built with the steering wheel.

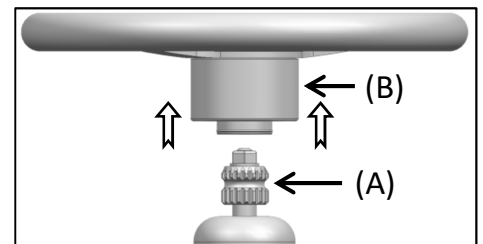
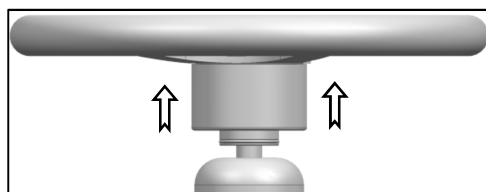
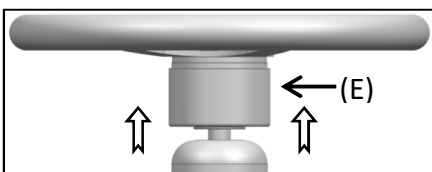

✓ **How to engage the steering wheel.**

1. Insert the support (B) in the insert (A), taking care of matching the wider groove with the centering tooth (pt. 4).
2. The steering wheel will go down halfway the insert (A) and then it stops.

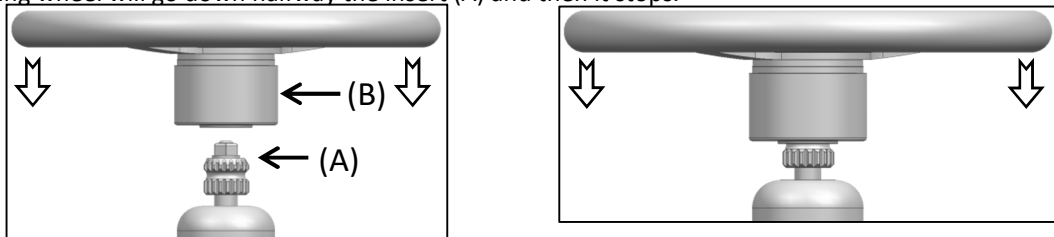

3. Pull up the release part (E) and push further down the steering wheel in order to fully engage the insert (A) (during this procedure keep always the release part (E) pulled towards the steering wheel).

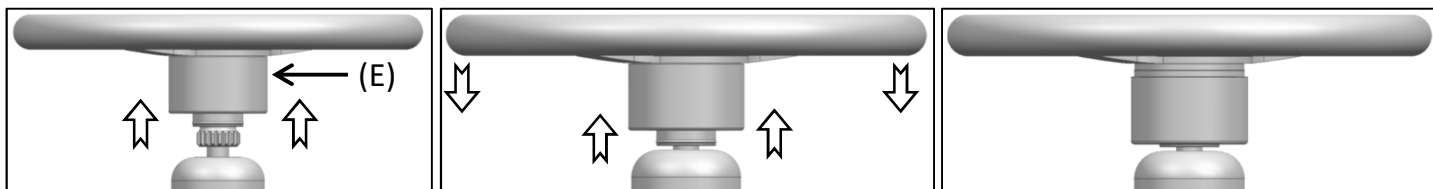

4. If this procedure is carried out properly, the hub will be completely inserted on the fixed insert (A) and the release part (E), once released, will come back to the working position (you should hear a click at the end of this procedure).

✓ **How to check that the installation was successful.**

- The gear on the fixed insert (A) should not be visible.
- Try to pull the steering wheel in the opposite direction, as if you wished to remove it, with both the hands acting only on the steering wheel grip: the steering wheel has not to move and come out, but it has to stay fixed on the insert (A). If it is not fixed, please repeat the procedure again, checking that the release part (E) always comes back to the working position, when not pulled.

7) STEERING WHEEL CENTERING

- The QDH has one matching position (pt. 4) which defines the orientation of the steering wheel once installed the QDH on the helm shaft.
- In case of a non equidistant spokes steering wheel, you may notice that installing the steering wheel straight the rudder is not in the center and as a consequence the boat does not go straight.
- In order to avoid it, before installing the steering wheel frame to the support (B) (pt. 4), check that the rudder is straight and choose the set of 6 holes that allows to install the steering wheel straight oriented.

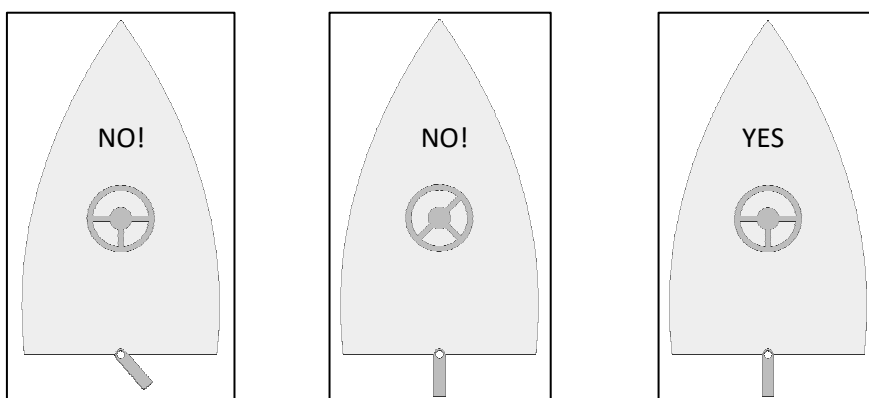

8) WARNINGS

⚠ DANGER!

Before starting the engine of the boat, make sure that the steering wheel is properly connected to the helm shaft!

⚠ DANGER!

Never remove the steering wheel during the navigation!

⚠ DANGER!

THE SHORTAGE OF OBSERVANCE OF THESE WARNINGS CAN LEAD TO IMMEDIATE DAMAGES THAT CAUSE SERIOUS INJURYIES OR DEATH.

TECHNICAL SERVICE

UFLEX S.r.l.

Via Milite Ignoto,8A
16012 Busalla (GE) - Italia
Tel: +39.010.962.01
Email: service@ultraflexgroup.it
www.ultraflexgroup.it

UFLEX USA

North - South - Central America:
UFLEX USA
6442 Parkland Drive
Sarasota, FL 34243
Tel: +1.941.351.2628
Email: sales@uflexusa.com
www.uflexusa.com